

# Instruction manual

## VA 525

Compact inline flow sensor with  
integrated flow straightener



## **I. Foreword**

Dear customer,

thank you very much for deciding in favour of the VA 525. Please read this installation and operation manual carefully before mounting and initiating the device and follow our advice. A riskless operation and a correct functioning of the VA 525 are only guaranteed in case of careful observation of the described instructions and notes



### **Sales Office South / Geschäftsstelle Süd**

Zindelsteiner Str. 15

D-78052 VS-Tannheim

Tel.: +49 (0) 7705 978 99 0

Fax: +49 (0) 7705 978 99 20

Mail: [info@cs-instruments.com](mailto:info@cs-instruments.com)

Web: <http://www.cs-instruments.com>

### **Sales Office North / Geschäftsstelle Nord**

Gewerbehof 14

D-24955 Harrislee

Tel.: +49 (0) 461 807 150 0

Fax: +49 (0) 461 807 150 15

Mail: [info@cs-instruments.com](mailto:info@cs-instruments.com)

Web: <http://www.cs-instruments.com>

---

**II. Table of Contents**

<b>I. Foreword .....</b>	<b>2</b>
<b>II. Table of Contents .....</b>	<b>3</b>
<b>1 Intended use.....</b>	<b>5</b>
<b>2 Safety instructions.....</b>	<b>5</b>
<b>3 Instruments description .....</b>	<b>6</b>
<b>4 Technical data.....</b>	<b>7</b>
<b>5 Scaling Analogue output Compressed Air.....</b>	<b>8</b>
<b>6 Installation Description .....</b>	<b>8</b>
<b>6.1 Installation of VA 525.....</b>	<b>8</b>
<b>7 Flow measuring ranges .....</b>	<b>9</b>
<b>7.1 Flow for different gases.....</b>	<b>9</b>
<b>8 Dimensions .....</b>	<b>10</b>
<b>9 Electrical wiring .....</b>	<b>11</b>
<b>9.1 Modbus RTU, 4...20mA, Pulse, MBus or Ethernet.....</b>	<b>11</b>
<b>9.2 Connection diagrams .....</b>	<b>12</b>
9.2.1 Modbus .....	12
9.2.2 4..20mA / Impuls.....	12
9.2.3 MBus.....	12
9.2.4 Ethernet (optional PoE) .....	13

<b>10</b>	<b>Operation.....</b>	<b>14</b>
<b>10.1</b>	<b>Initialization .....</b>	<b>15</b>
<b>10.2</b>	<b>Main menu after switching on .....</b>	<b>15</b>
<b>10.3</b>	<b>Settings .....</b>	<b>16</b>
10.3.1	Settings Setup.....	17
10.3.1.1	Input / change tube diameter.....	17
10.3.1.2	Input / change consumption counter .....	18
10.3.1.3	Definition of the units for flow, velocity, temperature and pressure .....	18
10.3.1.4	Advanced settings .....	19
10.3.1.4.1	Definition of the reference conditions .....	19
10.3.1.4.2	Time setting for filtering .....	21
10.3.1.5	Setting of Zeropoint and Low-flow cut off .....	22
10.3.1.6	Pressur settings.....	23
10.3.2	Modbus settings.....	24
10.3.2.1	Modbus RTU Setup .....	24
10.3.3	Ethernet (Modbus TCP).....	25
10.3.3.1.1	Network Setup DHCP.....	25
10.3.3.2	Network Settings static IP.....	26
10.3.3.3	Modbus TCP Settings.....	27
10.3.3.4	Modbus Settings (2001...2005).....	28
10.3.3.5	Values Register (1001 ... 1500).....	28
10.3.4	Pulse /Alarm.....	30
10.3.4.1	Pulse output.....	30
10.3.5	User Setup .....	31
10.3.5.1	Password.....	31
10.3.5.2	Language.....	31
10.3.5.3	Display / Touch.....	32
10.3.6	Advanced.....	32
10.3.7	4 -20mA .....	33
10.3.8	VA 525 Info .....	35
<b>10.4</b>	<b>MBus.....</b>	<b>36</b>
10.4.1	Default Settings communication .....	36
10.4.2	Default values transmitted .....	36
<b>11</b>	<b>Status / Error messages .....</b>	<b>37</b>
<b>11.1</b>	<b>Status messages.....</b>	<b>37</b>
<b>11.2</b>	<b>Error messages .....</b>	<b>38</b>
<b>12</b>	<b>Maintenance.....</b>	<b>39</b>
<b>13</b>	<b>Cleaning of the sensor head.....</b>	<b>39</b>
<b>14</b>	<b>Re-Calibration .....</b>	<b>39</b>
<b>15</b>	<b>Spare parts and repair.....</b>	<b>39</b>
<b>16</b>	<b>Calibration.....</b>	<b>39</b>
<b>17</b>	<b>Warranty.....</b>	<b>39</b>

## 1 Intended use

The VA 525 consumption sensor is used for continuous flow measurements.

The VA 525 consumption sensor is designed and constructed exclusively for the intended purpose described here and may only be used accordingly.

The user must check whether the instrument is suitable for the selected application. It must be ensured that the medium is compatible with the wetted parts. The technical data listed in the data sheet are binding.

Improper handling or operation outside the technical specifications is not permitted. Claims of any kind based on improper use are excluded.

### Operating principle:

The VA 525 consumption probe operates according to the calorimetric measuring method.

The basis of this measuring method is the electrical heating of the mechanically protected built-in sensor. The mass flow, the volume flow and the flow velocity can be measured and determined by the resulting heat flow to the passing medium (gas).

With the calorimetric measurement method (based on the measurement principle), the operating temperature and pressure of the medium have no influence on the measurement result, only the material data of the gas component are decisive.

## 2 Safety instructions

### **Please read carefully before starting the device!**

Warning: Do not exceed the pressure range of 16 bar!

Observe the measuring range of the sensor!

Always observe the direction of flow when positioning the sensor!

The screwed fixture must be pressure tight.

It is absolutely necessary to avoid condensation on the sensor element or water drops in the measuring air as they may cause faulty measuring results.

The manufacturer cannot be held liable for any damage which occurs as a result of non-observance or non-compliance with these instructions. Should the device be tampered with in any manner other than a procedure which is described and specified in the manual, the warranty is cancelled and the manufacturer is exempt from liability.

The device is destined exclusively for the described application.

We offer no guarantee for the suitability for any other purpose and are not liable for errors which may have slipped into this operation manual. We are also not liable for consequential damage resulting from the delivery, capability or use of this device.

We offer you to take back the instruments of the instruments family VA 525 which you would like to dispose of.

Qualified employees from the measurement and control technology branch should only carry out adjustments and calibrations.

### 3 Instruments description

The newly developed VA 525 combines modern digital interfaces for connection to energy monitoring systems with a small, compact design. The VA 525 is always used when many machines (compressed air consumers) are to be connected/integrated to a energy monitoring network.

#### Special features:

- Compact, small design - for use in machines, behind the maintenance unit on the final consumers
- Screw-in thread for easy installation in existing pipelines due to integrated measuring block
  - Sizes : ¼", ½" ¾", 1" 1 ¼" , 1 ½" and 2"
- Integrated flow straighteners (no inlet runs necessary, except ¼")
- Integrated display with presentation of 2 values
  - Flow & Consumption,
  - Speed & Temperature
- Operation via integrated keyboard
  - Units selection  
freely selectable. m<sup>3</sup>/h, m<sup>3</sup>/min, l/min, l/s, kg/h, kg/min, g/s, lb/min, lb/h  
cfm, m/s,ft/min
- Digital interfaces
  - Modbus RTU (RS485)
  - Ethernet
  - MBus
- Analog interfaces
  - 4..20mA
  - Pulse output galv. insulated.
- Pressure measurement (optional)

#### Noze The optional CS Instruments Service Software enables you to:

- Selection/conversion of gas type (air, nitrogen, argon, nitrous oxide, CO<sub>2</sub>, oxygen)
- Scaling Analog output 4..20mA
- Read out service data
- sensor diagnosis

## 4 Technical data

<b>Measurement:</b>	<b>Flow and consumption</b>
<b>Reference Standard:</b>	Standard settings ex works: DIN 1945, ISO 1217 at 20°C and 1000 mbar
<b>Selectable Units</b>	<b>m<sup>3</sup>/h</b> (Standard settings ex works) m <sup>3</sup> /h, m <sup>3</sup> /min, l/min, l/s, kg/h, kg/min, g/s, lb/min, lb/h, cfm, m/s,ft/min
<b>Measuring principle:</b>	calorimetric measurement
<b>Sensor:</b>	Pt45, Pt1000
<b>Measuring medium:</b>	Air, gases
<b>Operating temperature:</b>	-30 ... 80°C probe tube -20 ... 70°C housing
<b>Operating pressure:</b>	up to 16 bar,
<b>Power supply:</b>	12 to 36 VDC <b>Optional:</b> Power over Ethernet according to IEEE 802.3af, class 2 (3.84...6.49 W, 36V-57V).
<b>Power consumption:</b>	max. 5W
<b>Digital output:</b>	RS 485 (Modbus RTU) Mbus (optional) Ethernet or Ethernet-PoE (optional)
<b>Analog output:</b>	4...20 mA (see chapter 4), max. burden < 500 Ohm
<b>Pulse output:</b>	pulse output potential free (dry contact) passive: max. 48Vdc, 150mA 1 pulse pro m <sup>3</sup> resp. pro l, Valency adjustable with the display keys
<b>Accuracy:</b>	± 1,5 % m.v., ± 0,3 % f. s.*
<b>Display:</b>	TFT 1.8 Resolution 220 x 176 (optional)
<b>Mounting thread: measuring block</b>	G 1/4", G 1/2", G 3/4", G 1", G 1 1/4" G 1 1/2", G 2"
<b>Material measuring block:</b>	Aluminium
<b>Protection class:</b>	IP65

\* m.v. = measured values  
f.s. = full scale

## 5 Scaling Analogue output Comprssed Air

Reference DIN1945/ ISO 1217: 20°C, 1000 mbar (Reference during calibration)

Description	Version	Analogue output	
VA 525 with integrated ¼" measuring block	Low Speed	4... 20 mA =	0...25 l/min
	Standard		0...50 l/min
	Max		0...105 l/min
	High Speed		0...130 l/min
VA 525 with integrated ½" measuring block	Low Speed	4... 20 mA =	0...20 m³/h
	Standard		0...45 m³/h
	Max		0...90 m³/h
	High Speed		0...110 m³/h
VA 525 with integrated ¾" measuring block	Low Speed	4... 20 mA =	0...45 m³/h
	Standard		0...85 m³/h
	Max		0...175 m³/h
	High Speed		0...215 m³/h
VA 525 with integrated 1" measuring block	Low Speed	4... 20 mA =	0...75 m³/h
	Standard		0...145 m³/h
	Max		0...290 m³/h
	High Speed		0...355 m³/h
VA 525 with integrated 1¼" measuring block	Low Speed	4... 20 mA =	0...140 m³/h
	Standard		0...265 m³/h
	Max		0...530 m³/h
	High Speed		0...640 m³/h
VA 525 with integrated 1½" measuring block	Low Speed	4... 20 mA =	0...195 m³/h
	Standard		0...365 m³/h
	Max		0...730 m³/h
	High Speed		0...885 m³/h
VA 525 with integrated 2" measuring block	Low Speed	4... 20 mA =	0...320 m³/h
	Standard		0...600 m³/h
	Max		0...1195m³/h
	High Speed		0...1450 m³/h

## 6 Installation Description

### 6.1 Installation of VA 525

The sensor VA 525 is pre-supplied with the measuring block.



- An installation at customer site is only allowed in the unpressurized state of the system.
- Tightness of the connection must be checked and ensured.



## 7 Flow measuring ranges

### 7.1 Flow for different gases

	1/4"	1/2"	3/4"	1"	1 1/4"	1 1/2"	2"
	Analog output 20mA	Analog output 20mA	Analog output 20mA	Analog output 20mA	Analog output 20mA	Analog output 20mA	Analog output 20mA
	l/min	[m <sup>3</sup> /h]	[m <sup>3</sup> /h]	[m <sup>3</sup> /h]	[m <sup>3</sup> /h]	[m <sup>3</sup> /h]	[m <sup>3</sup> /h]

**Reference DIN1945/ ISO 1217: 20°C, 1000 mbar (Reference during calibration)**

<b>Air</b>	Low Speed	<b>25</b>	<b>20</b>	<b>45</b>	<b>75</b>	<b>140</b>	<b>195</b>	<b>320</b>
	Standard	<b>50</b>	<b>45</b>	<b>85</b>	<b>145</b>	<b>265</b>	<b>365</b>	<b>600</b>
	Max	<b>105</b>	<b>90</b>	<b>175</b>	<b>290</b>	<b>530</b>	<b>730</b>	<b>1195</b>
	High Speed	<b>130</b>	<b>110</b>	<b>215</b>	<b>355</b>	<b>640</b>	<b>885</b>	<b>1450</b>

**Adjustment to DIN 1343: 0°C, 1013,25 mbar**

<b>Air</b>	Low Speed	<b>25</b>	<b>20</b>	<b>40</b>	<b>70</b>	<b>130</b>	<b>180</b>	<b>295</b>
	Standard	<b>50</b>	<b>40</b>	<b>80</b>	<b>135</b>	<b>240</b>	<b>335</b>	<b>550</b>
	Max	<b>100</b>	<b>80</b>	<b>160</b>	<b>270</b>	<b>485</b>	<b>670</b>	<b>1100</b>
	High Speed	<b>120</b>	<b>100</b>	<b>195</b>	<b>325</b>	<b>590</b>	<b>815</b>	<b>1330</b>
<b>Nitrogen (N<sub>2</sub>)</b>	Low Speed	25	20	40	70	130	180	295
	Standard	50	40	80	135	240	335	550
	Max	100	80	160	270	485	670	1100
	High Speed	120	100	195	325	590	815	1330

Other gases on request

**Please note:**

The area outside the pipeline (ambient area of the sensor) must not be an explosive area.

## 8 Dimensions

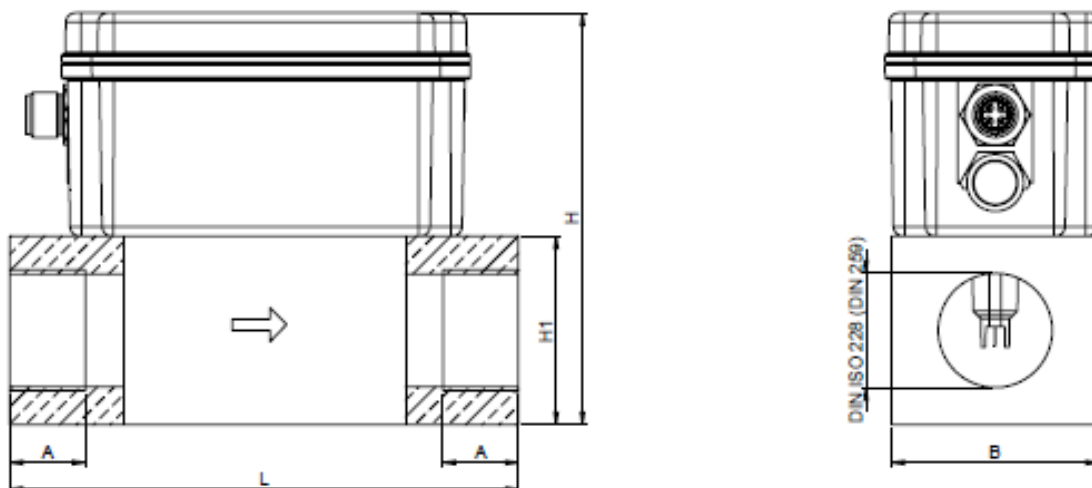

Nominal width	Connection thread	L [mm]	B [mm]	H1 [mm]	H [mm]	A [mm]
DN 8	G 1/4"	135	55	50	109,1	15
DN 15	G 1/2"	135	55	50	109,1	20
DN 20	G 3/4"	135	55	50	109,1	20
DN 25	G 1"	135	55	50	109,1	25
DN 32	G1 1/4"	135	80	80	139,1	25
DN 40	G1 1/2"	135	80	80	139,1	25
DN 50	G 2"	135	80	80	139,1	30

### 8.1 Mounting holes

DN15 – DN25

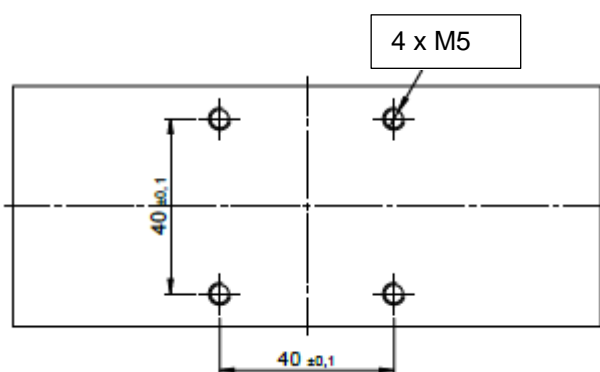

DN32 – DN50

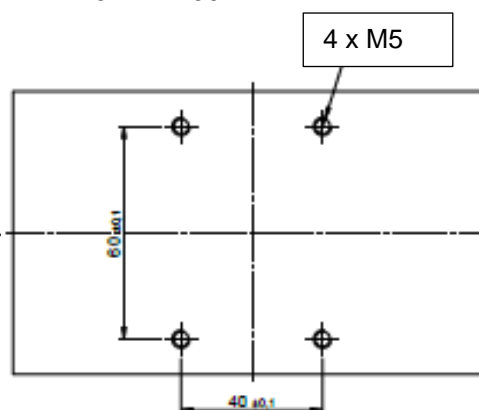

## 9 Electrical wiring

### 9.1 Modbus RTU, 4...20mA, Pulse, MBus or Ethernet

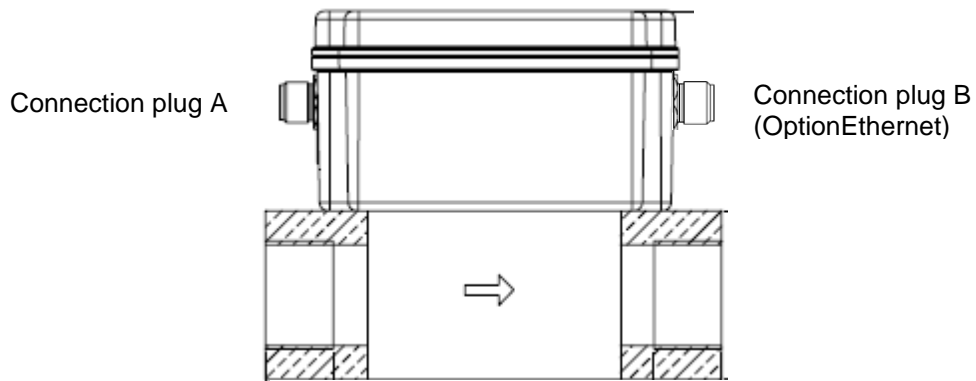

**Attention:** Not required connections NC must not be connected to a voltage and/or to protection earth. Cut and insulate cables.

	Pin 1	Pin 2	Pin 3	Pin 4	Pin 5
<b>Connector plug A</b> Version Modbus	+VB	RS 485 (A)	-VB	RS 485 (B)	NC
<b>Connector plug A</b> (Version 4..20mA)	+VB	Pulse galv. isolated	-VB	Pulse galv. isolated	I+ 4..20 mA
<b>Connector plug A</b> Version MBus	+VB	NC	-VB	MBus	MBus
Colours cables 0553.0106 (5 m) 0553.0107 (10 m)	brown	white	blue	black	grey

**Legend:**

-VB	Negative supply voltage 0 V
+VB	Positive supply voltage 18...36 VDC smoothed
I +	Current signal 4...20 mA (selected measured signal)
RS 485 (A) RS 485 (B)	Modbus RTU A Modbus RTU B

Pulse	Pulse for consumption
NC	Must not be connected to a voltage and/or to protection earth. Please cut and isolate cables.
MBus	MBus (reverse polarity protected)

If no connection cable is ordered the sensor will be supplied with a M12 connector plug. The user can connect the supply and signal cables as indicated in the connection diagram.

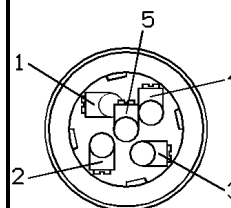

**M12 Connector plug**  
View from back side (terminal side)

## 9.2 Connection diagrams

### 9.2.1 Modbus

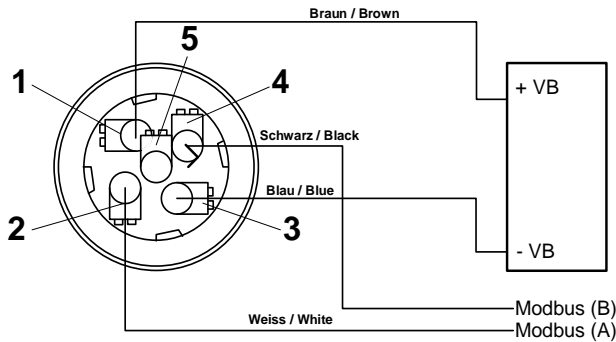

**Remark:** If the sensor is placed at the end of the Modbus system a termination is required. The sensors have an internal switchable termination, therefore the 6 fastening screws from the lid are to be released and set the internal DIP Switch to "On". It must be ensured that the connection plugs are still plugged and the gasket is installed correctly.

Alternatively, a 120R resistor can be installed in the plug between pin 2 and pin 4.

### 9.2.2 4..20mA / Impuls

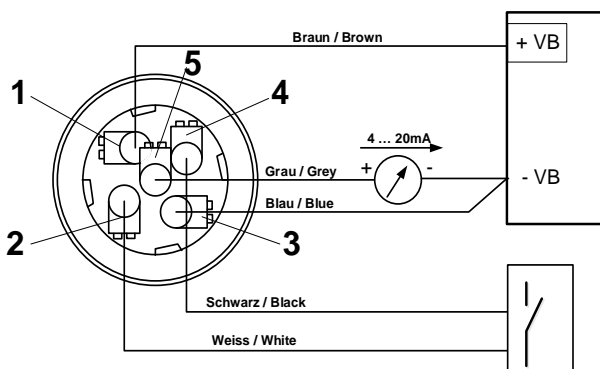

### 9.2.3 MBus

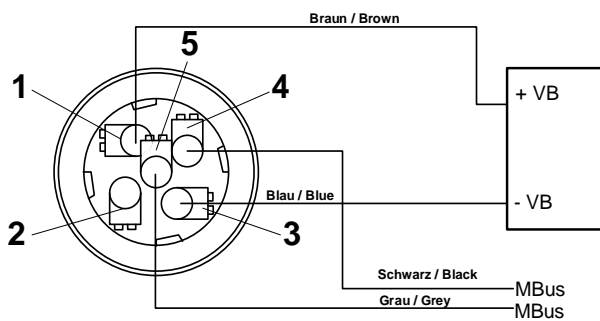

### 9.2.4 Ethernet (optional PoE)

#### Connector plug B

M12 x-coded 8 pole

Data LINES: 1,2 und 3,4

PoE LINES: 5,6 und 7,8

#### Connection cable

M12 x-coded to RJ45

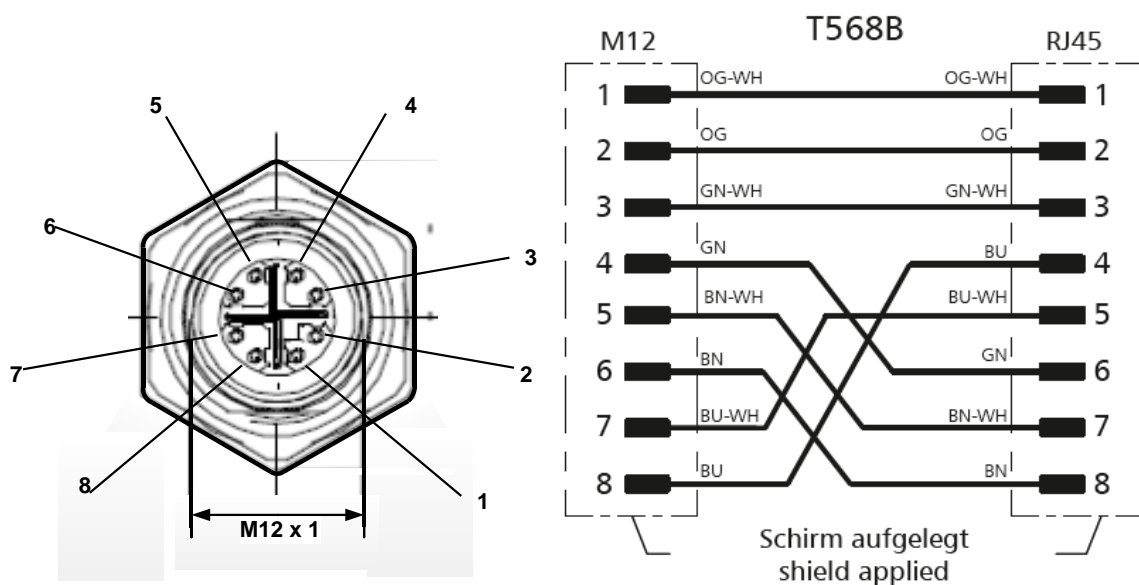

Connection cable: Cat 6.

\*PoE: Power over Ethernet

## 10 Operation

**Remark:** Only for version with display



“Up“ (  $\triangle$  )   “OK“ (  $\blacktriangledown$  )

---

The operation of the VA 525 is done by the two capacitive key buttons Up ( $\triangle$ ) and Enter ( $\blacktriangledown$ )

### 10.1 Initialization

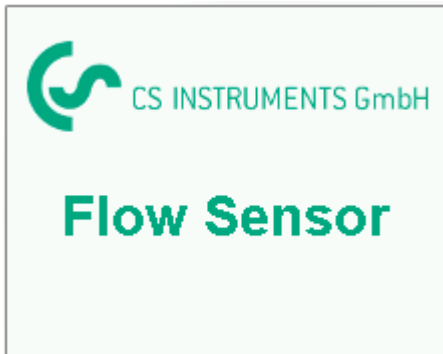

After switching on the VA 525, the initialized screen is displayed followed by the main menu.

### 10.2 Main menu after switching on

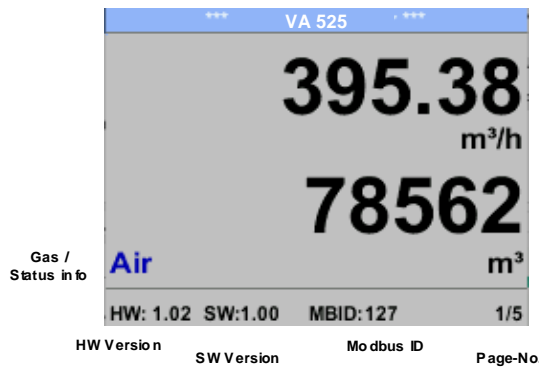

Switching to pages 2-5 or back by pressing key „△“

Available only with option „Pressure”

*** Compressed Air ***				*** Compressed Air ***			
83.25 m/s		24.1 °C		920.35 mbar		901.85 932.15 mbar	
Air				Air			
HW: 1.02 SW:1.00 MBID:127		2/5		HW: 1.02 SW:1.00		3/5	
*** Average Min Max ***				*** Average Min Max ***			
Flow: m³/h		AV Min Max		Velocity: m/s		AV Min Max	
395.38		207.45 870.87 0		83.25		55.92 152.87 0	
Total Counter: m³		78562		Temperature: °C		24.1 21.3	
82.7				23.7		24.6	
AV-Time: 1440 minutes		4/5		AV-Time: 1440 minutes		5/5	

AV-Time ( Period for average value calculation) could be changed under *Sensor Setup.-Advanced- AV-Time*

### 10.3 Settings

The settings menu could accessed by pressing the key „OK“, selection of „Yes“ with button „△“. Then the entry has to be confirmed with „OK“.



But the access to the *settings menu* is password protected.



Factory settings for password at the time of delivery: 0000 (4 times zero).

If required the password could be changed at *Setup-User setup-Password*.

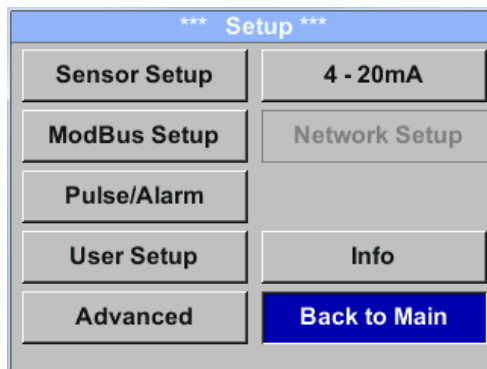

Selection of a menu item or to change a value is done with the key „△“, a final move to the chosen menu item or takeover of the value change needs the confirmation by pressing the key „OK“

Menu items

- 4..20mA / pulse alarm,
- Network setup
- MBus

only available with corresponding sensor version.

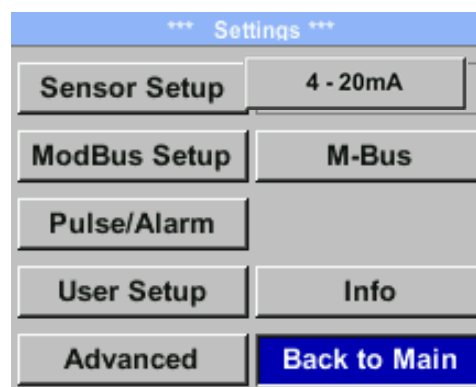
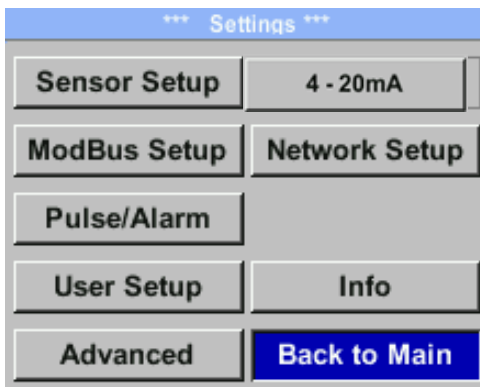



### 10.3.1 Settings Setup

*Settings* → *Sensor Setup*

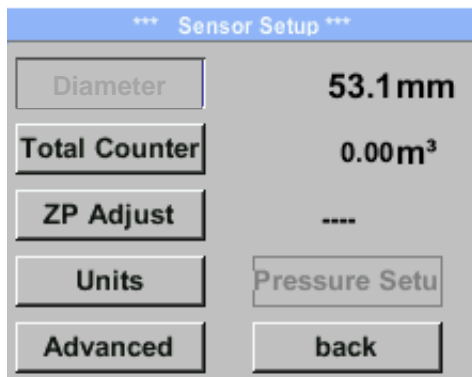

For changes, first select the menu item with key „△“ and then confirm it with “OK”.

#### 10.3.1.1 Input / change tube diameter

For the VA 525 not adjustable (suspended) as voted on included measuring section with corresponding measurement block diameter.

10.3.1.2 Input / change consumption counter

Setup → Sensor Setup → Total Counter → Unit button

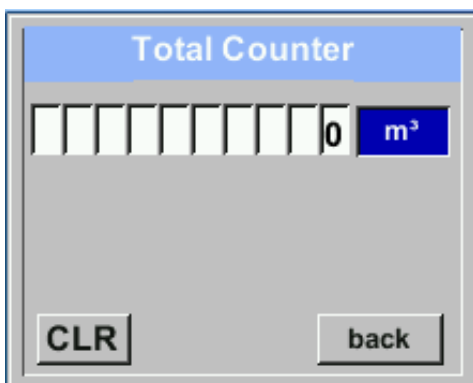
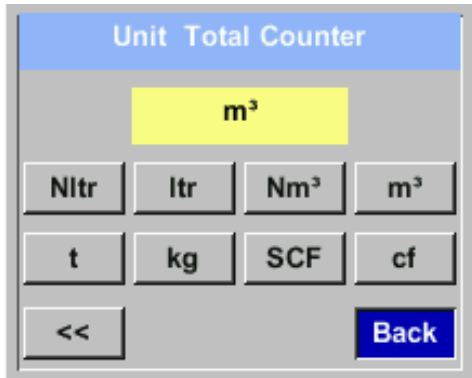

In order to change, e.g. the unit, first select by pressing key „Δ“ the button **“Unit”** and then key **“OK”**.

Select with the key „Δ“ the correct unit and then confirm selection by pressing 2x **„OK”**.

Entering / changing the consumption counter via button „Δ“, select the respective position and activate the position with the **“OK”** button.

By pressing „Δ“ the position value is incremented by 1. Complete with **“OK”** and activate next number position.

Confirm entry by pressing **„OK”**.

**Unit selection:**

- according to chapter 10.3.1.3
- Direct selection of the unit button and call of the unit page with **„OK”**.

**Important!**

When the counter reach 10000000 m³ the counter will be reset to zero.

10.3.1.3 Definition of the units for flow, velocity, temperature and pressure

Setup → Sensor Setup → Units

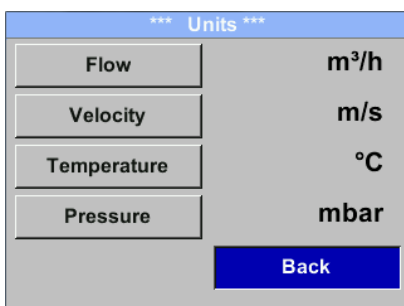

To make changes to the unit for the respective measurement value, first select by pressing „Δ“ the field of the „measurement value“ and activate „it with **„OK”** .

Selection of the new unit with **„Δ”**

In case the quantity of units selectable are not presentable on one page, pleas move to next page by pressing **„<<”** .

Confirm selection by pressing 2x **„OK”**.

Procedure for all 4 measurement variables is analogous.

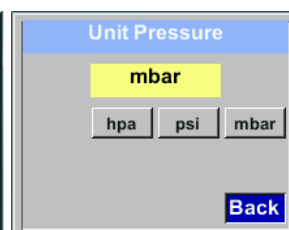
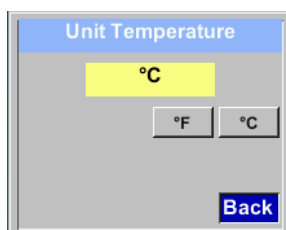
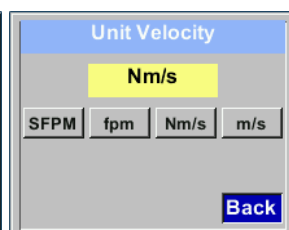
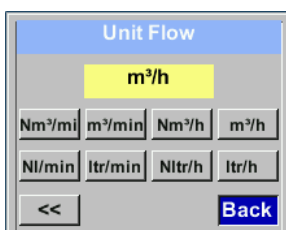

### 10.3.1.4 Advanced settings

Setup → Sensor Setup → Advanced

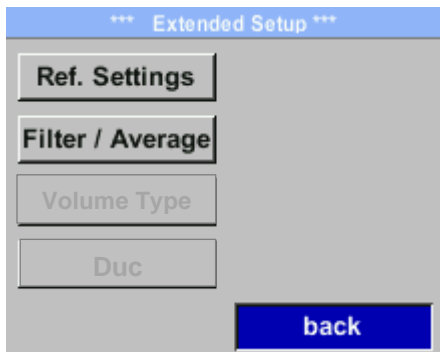

#### 10.3.1.4.1 Definition of the reference conditions

Here can be defined the desired measured media reference conditions for pressure and temperature and times for the filter and averaging.

- Factory presetting for reference temperature and reference pressure are 20 °C, 1000 hPa
- All volume flow values (m<sup>3</sup>/h) and consumption values indicated in the display are related to 20 °C and 1000 hPa (according to ISO 1217 intake condition)
- Alternatively 0 °C and 1013 hPa (=standard cubic meter) can also be entered as a reference.
- **Do not enter the operation pressure or the operation temperature under reference conditions!**

Setup → Sensor Setup → Advanced → Ref. Settings

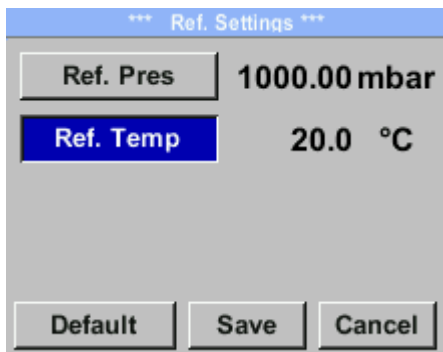

To make changes, first select a menu with button „△“ and confirm selection by pressing „OK“.

Setup → Sensor Setup → Advanced → Ref. Settings → Ref.Pref

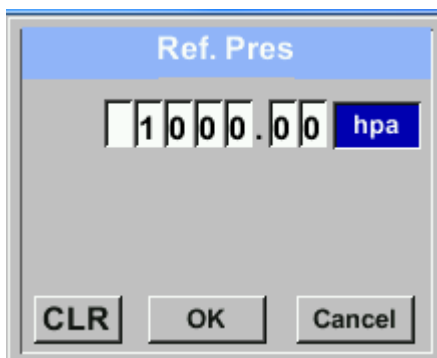

Setup → Sensor Setup → Advanced → Ref. Settings → Ref.Temp

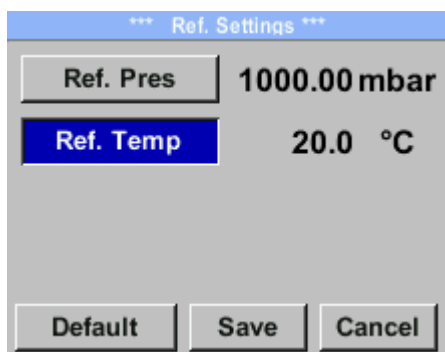
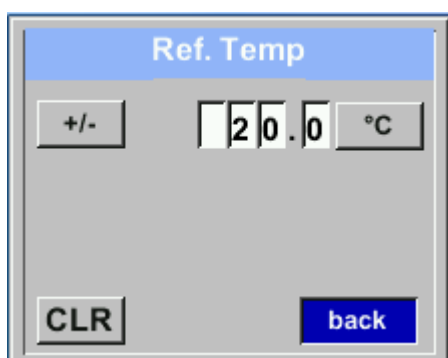

In order to change, e.g. the unit, first select by pressing key „ $\Delta$ “ the field **“Units”** and then key **“OK”**.

Select with the key „ $\Delta$ “ the correct unit and then confirm selection by pressing 2x **„OK”**.

Input / change of the value by selecting the respective position with button „ $\Delta$ “ and entering by pressing button **„OK”**.

By pressing „ $\Delta$ “ the position value is incremented by 1. Complete with **„OK”** and activate next number position.

Procedure for changing the reference temperature is the same.

**Unit selection:**

- according to chapter 10.3.1.3
- Direct selection of the unit button and call of the unit page with **„OK”**.

All changes have to be stored by pressing **„Save”**.

With **„Default”** the sensor is reset to calibration settings.

10.3.1.4.2 Time setting for filtering

Setup → Sensor Setup → Advanced → Ref. Settings → Filtertime

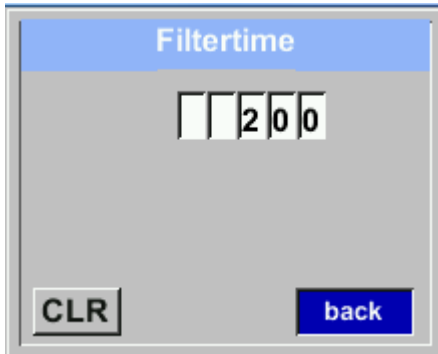

Under item **"Filtertime"** an attenuation can be defined.  
Input values of 0 -10000 in [ms] are possible

Setup → Sensor Setup → Advanced → Ref. Settings → AV-Time

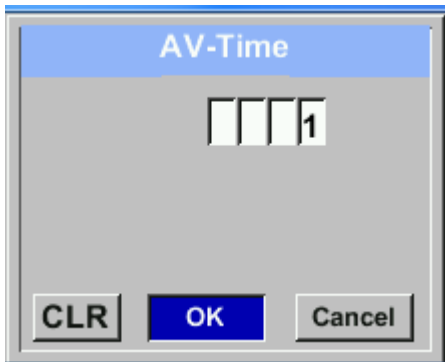

The time period for averaging can be entered here.  
Input values of -1440 1 [minutes] are possible.  
For average values see display window 3 + 4

10.3.1.5 Setting of Zeropoint and Low-flow cut off

Setup → Sensor Setup → ZP Adjust

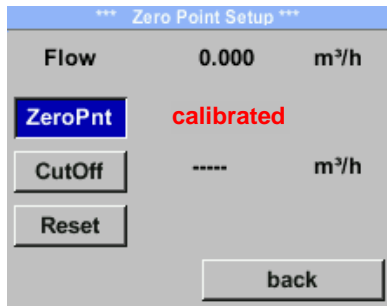

To make changes, first select a menu with button „ $\Delta$ “ and confirm selection by pressing „OK“.

Setup → Sensor Setup → ZP Adjust → ZeroPnt

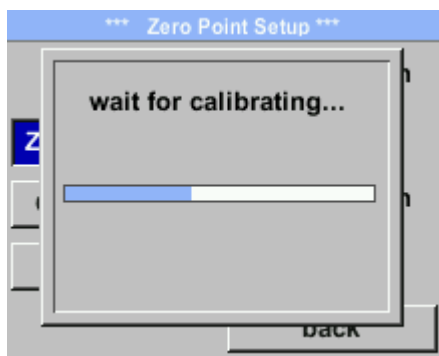

When, without flow, the installed sensor shows already a flow value of  $> 0$  m<sup>3</sup>/h herewith the zero point of the characteristic could be reset. With selection the "ZeroPnt" key and pressing the "OK" key, an automatic zero point calibration is carried out.

In case there is already a calibration done, it is indicated in menu with "calibrated"

Leave menu with button „Back“

Setup → Sensor Setup → ZP Adjust → CutOff

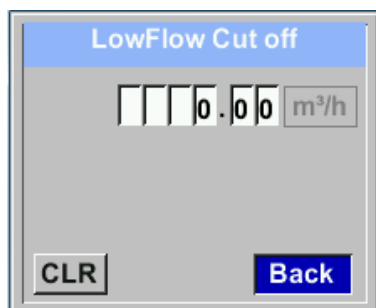

With the low-flow cut off activated, the flow below the defined "LowFlow Cut off" value will be displayed as 0 m<sup>3</sup>/h and not added to the consumption counter.

For an input / change of the value select with the button „ $\Delta$ “ the respective number position and activate it with „OK“.

By pressing „ $\Delta$ “ the position value is incremented by 1. Confirm the input with „OK“ and activate next number position.

Leave menu with button „Back“

Setup → Sensor Setup → ZP Adjust t → Reset

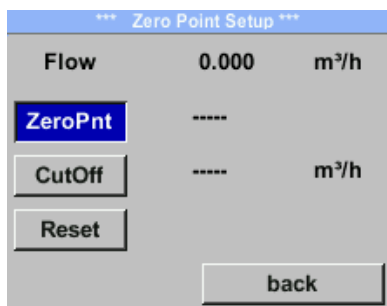

By selection of „Reset“ all settings for „ZeroPnt“ and „CutOff“ are reset.

Menu item to be select with button „ $\Delta$ “ and confirm the reset with „OK“.

Leave menu with button „Back“

### 10.3.1.6 Pressiere settings

Setup → Sensor Setup → Pressure

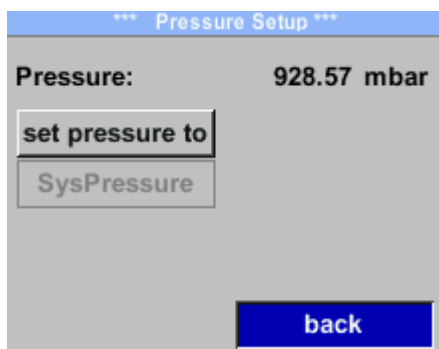

If necessary, a pressure correction can be made by selecting **"Set pressure to"**.

Select the menu item with the „**Δ**“ key and then select it with the **"OK"** key.

Enter the corresponding pressure value in the input menu and save changes with **"OK"**.

Press the **"CLR"** key to reset the value.

Exit the menu with **"Cancel"**.

### 10.3.2 Modbus settings

#### 10.3.2.1 Modbus RTU Setup

The Flow sensors VA 525 comes with a Modbus RTU Interface. Before commissioning the sensor the communication parameters

- Modbus ID, Baudrate, Parity und Stop bit

must be set in order to ensure the communication with the Modbus master.

#### Settings → Modbus Setup

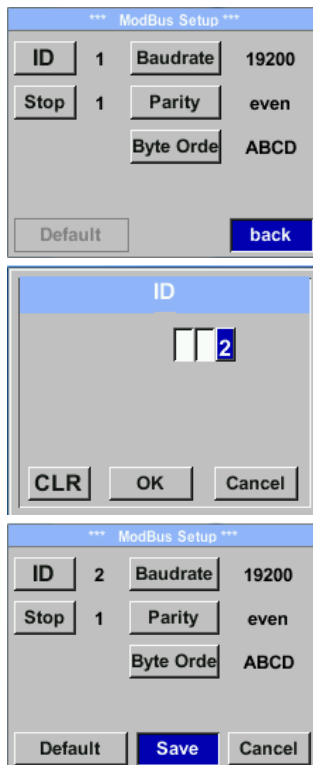

For changes, e.g. the sensor ID, first select by pressing key „△“ the field “ID” and then key “OK”.

Select the desired position by pressing the “>” and select with “OK” button.

Change values by pressing the „△“ values takeover by pressing “OK”.

Inputs for baudrate, stopbit and parity is done analogue.

By means of the button "Byte Order" it is possible to change the data format (Word Order). Possible formats are "ABCD" (Little Endian) and "CDAB" (Middle Endian)

Saving the changes by pressing “Save”, therefore select it with key „△“ and then confirm it with “OK”.

**Default values out of factory:**

Modbus ID:	1
Baud rate:	19200
Stopbit:	1
Parity:	even
Byte Order:	ABCD

**Remark:** If the sensor is placed at the end of the Modbus system a termination is required. The sensors have an internal switchable termination, therefore the 4 fastening screws from the lid are to be released and set the internal DIP Switch to “On”.



Alternatively, a 120R resistor can be installed in the plug between pin 2 and pin 4.

It must be ensured that the connection plugs are still plugged and the gasket is installed correctly.



### 10.3.3 Ethernet (Modbus TCP)

The Flow sensors VA 525 comes optional with a Modbus TCP Interface (HW Interface:M12 x 1 X-coded connector).

Device supports with this option the Modbus TCP protocol for communication with SCADA systems. TCP port is set to 502 by default. Port can be changed at the sensor or using PC Service Software

Modbus device address (Unit Identifier) can be set in the range of 1- 255.

Specification and description of the Modbus protocol is free to download on: [www.modbus.org](http://www.modbus.org).

Supported Modbus commands (functions):

Command	Code	Description
Function Code	3	(Read holding register)
Function code	16	(Write multiple registers)

For more details, please see **VA 5xx Modbus RTU\_TCP Installation V1.06**

#### Settings → Network Setup

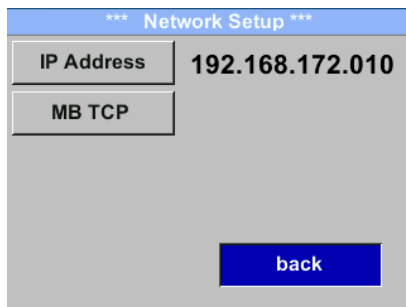

#### 10.3.3.1.1 Network Setup DHCP

#### Settings → Network Setup Settings → IP Address

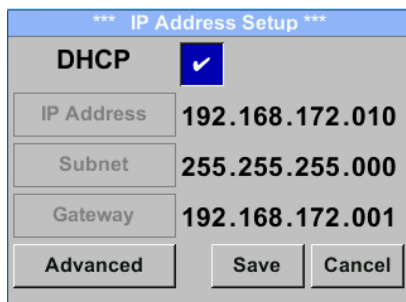

Here you can set up and made a connection, with or without *DHCP*, to a computer.

**Remark:**

With activated *DHCP* the automatic integration of the sensor in an existing network is possible, without a manual configuration.

Storing of settings by pressing “*Save*”

### 10.3.3.2 Network Settings static IP

Settings → Network Setup Settings → IP Address → IP Address

Settings → Network Setup Settings → IP Address → Subnet

Settings → Network Setup Settings → IP Address → Gateway

\*\*\* IP Address Setup \*\*\*

DHCP

IP Address 192.168.172.010

Subnet 255.255.255.000

Gateway 192.168.172.001

Advanced back

\*\*\* IP Address Setup \*\*\*

DHCP

IP Address 192.168.172.010

Subnet 255.255.255.000

Gateway 192.168.172.001

Advanced back

IP Setup

1 9 2

CLR back

For manual (static) IP, the "IP Address", "Subnet" and "Gateway" selection keys must be selected and activated with "OK".

The first data field of the selection, in this case the IP address, is then marked (red).

Confirm with "OK" the corresponding input menu is opened.

By means of ">", the next data field is changed.

Select the desired position with the ">" key and activate it with the "OK" key.

Change the values with the ">" key, and accept the values with the "OK" key.

Procedure for "Subnet" and "Gateway" is analogous.

Subnet Setup

2 5 5

CLR back

Gateway Setup

1 9 2

CLR back

\*\*\* IP Address Setup \*\*\*

DHCP

IP Address 192.168.172.011

Subnet 255.255.255.000

Gateway 192.168.172.001

Advanced Save Cancel

Store the settings by „Save“

### 10.3.3.3 Modbus TCP Settings

Settings → Network Setup Settings → IP Address → MB TCP

Settings → Network Setup Settings → IP Address → ID

Settings → Network Setup Settings → IP Address → Port

For changes, e.g. the sensor ID, first select by pressing key „>“ the field **“ID”** and then key **“OK”**.

Select the desired position by pressing the **“>”** and select with **“OK”** button.

Change values by pressing the **„>“** values takeover by pressing **“OK”**.

Input for the port is done analogue.

By means of the button **“Byte Format”** it is possible to change the data format (Word Order). Possible formats are **“ABCD”** (Little Endian) and **“CDAB”** (Middle Endian)

Saving the changes by pressing **“Save”**, therefore select it with key **„>“** and then confirm it with **“OK”**.

Reset to the default settings by activating **“Set to Default”**-

**10.3.3.4 Modbus Settings (2001...2005)**

Modbus Register	Register Address	No. of Byte	Data Type	Description	Default Setting	Read Write	Unit /Comment
2001	2000	2	UInt16	Modbus ID	1	R/W	Modbus ID 1...247
2002	2001	2	UInt16	Baudrate	4	R/W	0 = 1200 1 = 2400 2 = 4800 3 = 9600 4 = 19200 5 = 38400
2003	2002	2	UInt16	Parity	1	R/W	0 = none 1 = even 2 = odd
2004	2003	2	UInt16	Number of Stopbits		R/W	0 = 1 Stop Bit 1 = 2 Stop Bit
2005	2004	2	UInt16	Word Order	0xABCD	R/W	0xABCD = Big Endian 0xCDAB = Middle Endian

**10.3.3.5 Values Register (1001 ...1500)**

Modbus Register	Register Address	No. of Byte	Data Type	Description	Default	Read Write	Unit /Comment
1101	1100	4	Float	Flow in m <sup>3</sup> /h		R	
1109	1108	4	Float	Flow in Nm <sup>3</sup> /h		R	
1117	1116	4	Float	Flow in m <sup>3</sup> /min		R	
1125	1124	4	Float	Flow in Nm <sup>3</sup> /min		R	
1133	1132	4	Float	Flow in ltr/h		R	
1141	1140	4	Float	Flow in Nltr/h		R	
1149	1148	4	Float	Flow in ltr/min		R	
1157	1156	4	Float	Flow in Nltr/min		R	
1165	1164	4	Float	Flow in ltr/s		R	
1173	1172	4	Float	Flow in Nltr/s		R	
1181	1180	4	Float	Flow in cfm		R	
1189	1188	4	Float	Flow in Ncfm		R	
1197	1196	4	Float	Flow in kg/h		R	
1205	1204	4	Float	Flow in kg/min		R	
1213	1212	4	Float	Flow in kg/s		R	
1221	1220	4	Float	Flow in kW		R	

Modbus Register	Register Address	No. of Byte	Data Type	Description	Default	Read Write	Unit /Comment
1269	1268	4	UInt32	Consumption m <sup>3</sup> before comma	x	R	
1275	1274	4	UInt32	Consumption Nm <sup>3</sup> before comma	x	R	
1281	1280	4	UInt32	Consumption ltr before comma	x	R	
1287	1286	4	UInt32	Consumption Nltr before comma	x	R	
1293	1292	4	UInt32	Consumption cf before comma	x	R	
1299	1298	4	UInt32	Consumption Ncf before comma	x	R	
1305	1304	4	UInt32	Consumption kg before comma	x	R	
1311	1310	4	UInt32	Consumption kWh before comma	x	R	
1347	1346	4	Float	Velocity m/s			
1355	1354	4	Float	Velocity Nm/s			
1363	1362	4	Float	Velocity Ft/min			
1371	1370	4	Float	Velocity NFt/min			
1419	1418	4	Float	GasTemp °C			
1427	1426	4	Float	GasTemp °F			
1475	1474	4	Float	Systempressure mbar	X	R	Value only available with pressure option
1487	1486	4	Float	Systempressure psi		R	Value only available with pressure option

**Remark:**

- **For DS400 / DS 500 / Handheld devices - Modbus Sensor Datatype**  
„Data Type R4-32“ match with „Data Type Float“
- For more additional Modbus values please refer to  
VA5xx\_Modbus\_RTU\_Slave\_Installation\_1.06\_EN.doc

### 10.3.4 Pulse /Alarm

#### Settings → Pulse/ Alarm

\*\*\* Pulse / Alarm \*\*\*

**Relay Mode:** Pulse

Unit: m<sup>3</sup>

Value: 0.1

Polarity: pos.

Pls per second at max Speed: 0

Back

**Relay Mode:** Alarm

Unit: °C

Value: 20.0

Hyst.: 5.0

Hi-Lim. OK Cancel

\*\*\* Pulse / Alarm \*\*\*

**Relay Mode:** Pulse

Unit: m<sup>3</sup>

Value: 0.1

Polarity: pos.

Pls per second at max Speed: 0

Back

The galvanically isolated output can be defined as pulse- or alarm output. Selection of field „**Relay Mode**“ with key „**Δ**“ and change modus by pressing key „**OK**“.

For alarm output following units could be chosen: Nm/s, m/s, Nm<sup>3</sup>/h, m<sup>3</sup>/h, Nltr/h, ltr/h, Nm<sup>3</sup>/min, m<sup>3</sup>/min, kg/s, kg/min, lb/s, lb/min, lb/h, SFPM, fpm, °C, °F

„**Value**“ defines the Alarm value, „**Hyst.**“ defines the desired hysteresis and with „**Hi-Lim**“ or „**Lo-Lim**“ the alarm settings when the alarm is activated

Hi-Lim: Value over limit

Lo-Lim: Value under limit

For the pulse output following units could be chosen: kg, cf, SCF, ltr, Nltr, Nm<sup>3</sup> and m<sup>3</sup>. The pulse value definition to be done in menu „**Value**“ . Lowest value is depending on max. flow of sensor and the max frequency of pulse output of 50Hz.

With „**Polarity**“ the switching state could be defined. Pos. = 0 → 1 neg. 1 → 0

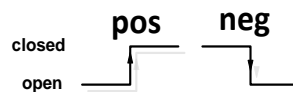

#### 10.3.4.1 Pulse output

The maximum frequency for pulse output is 50 pulses per second (50Hz).

The Pulse output is delayed by 1 second.

Pulse value	[m <sup>3</sup> /h]	[m <sup>3</sup> /min]	[l/min]
0.1 ltr / Pulse	18	0,3	300
1ltr / Pulse	180	3	3000
0.1m <sup>3</sup> / Pulse	18000	300	300000
1 m <sup>3</sup> / Pulse	180000	3000	3000000

Table 1 Maximum flow for pulse output

Entering pulse values that are not allow a presentation to the full scale value, are not allowed. Entries are discarded and error message displayed.

### 10.3.5 User Setup

#### 10.3.5.1 Password

Settings → UserSetup → Password

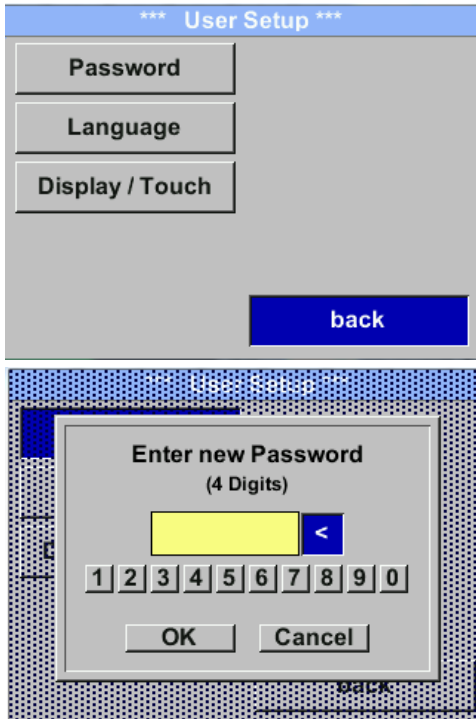

To make changes, first select a menu with button „ $\Delta$ “ and confirm selection by pressing „OK“.

It is possible to define a password. The required password length is 4 digits. Please select with button „ $\Delta$ “ a figure and confirm it with „OK“. Repeat this 4 times.

With „ $\Delta$ “ the last figure could be deleted. Password input have to be inserted twice.

Confirmation of input/password by pressing „OK“.

**Factory settings for password at the time of delivery: 0000 (4 times zero).**

#### 10.3.5.2 Language

Settings → UserSetup → Language

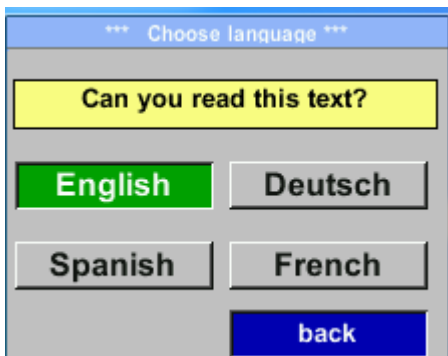

Currently 4 languages have been implemented and could be selected with button „ $\Delta$ “

Change of language by confirming with “OK”. Leaving the menu with button “back”.

### 10.3.5.3 Display / Touch

Settings → UserSetup → Display / Touch

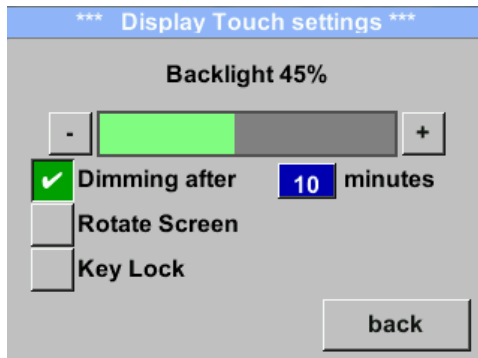

With the button „-“ and with button „+“ it is possible to adjust the backlight / display brightness. The actual / adjusted backlight brightness is shown in the graph „**Backlight.**“

By activation **“Dimming after”** and entering a time a display dimming could be set.

With **„Rotate Screen“** the display information could be rotated by 180°.

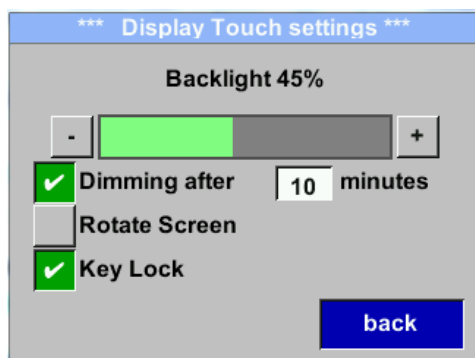

By activation of **„Key Lock“** the operation of the sensor locked.

Unlocking the keyboard is only possible by restarting the sensor and calling the operating menu within the first 10s. To do this, use the **“OK”** button to enter the operating menu during this period

### 10.3.6 Advanced

Settings → Advanced

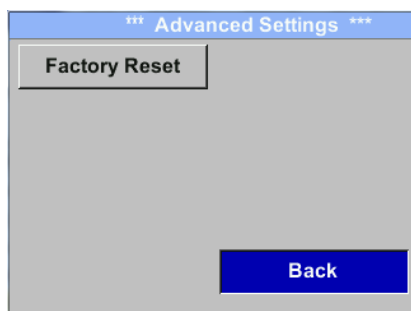

By pressing **„Factory Reset“** the sensor is set back to the factory settings.



### 10.3.7 4 -20mA

#### Settings → 4-20mA

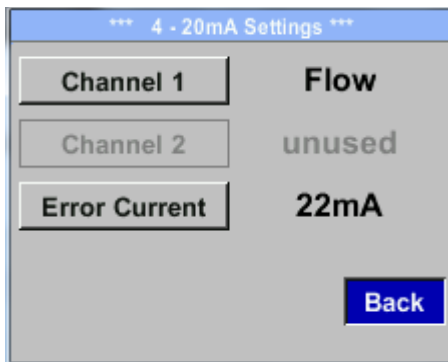

To make changes, first select a menu with button „ $\Delta$ “ and confirm selection by pressing „OK“.

#### Settings → 4-20mA → Channel 1

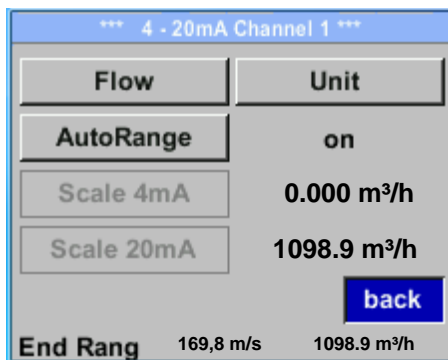

The 4-20 mA Analogue output of the Sensor VA 525 can be individually adjusted.

It is possible to assign following values „Temperature“, „Velocity“ und „Flow“ to the channel CH 1.

To make changes, first select the value item with button „ $\Delta$ “ .and confirm Moving between the different measurements values or to deactivate the 4-20mA with setting to „unused“ by pressing „OK“.

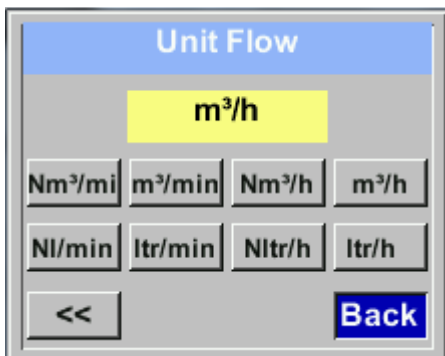

To the selected measurement value a corresponding / appropriate unit needs to be defined. Select „Unit“ with „ $\Delta$ “ and open menu with „OK“. Select required unit with „ $\Delta$ “ and take over by pressing „OK“.

Here e.g. for the measurement value Flow, procedure for the other measurements values is analog.

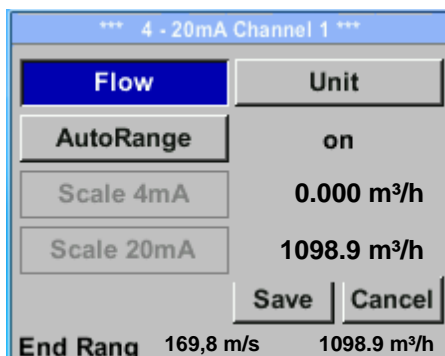

For saving the changes done press button „Save“ to discard the changes press button „Cancel“.

Leaving the menu with „Back“.

Settings → 4-20mA → Channel 1 → AutoRange

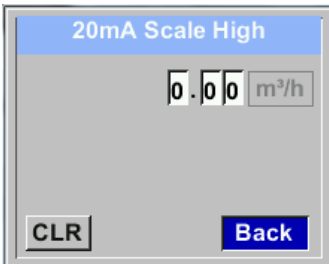
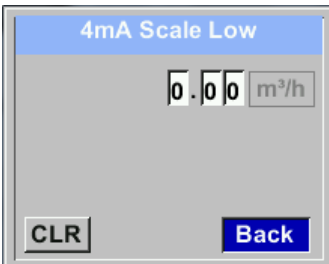
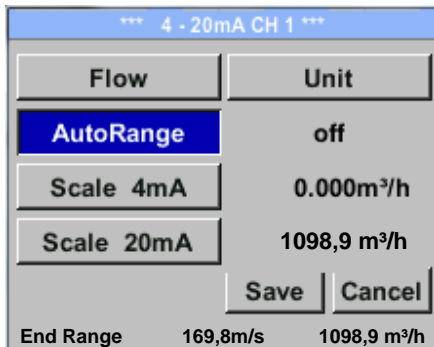

The scaling of the 4-20mA channel can be done automatically "Auto Range = on" or manual "AutoRange = off" .

With button „ $\Delta$ “ select the menu item „AutoRange“ select with „OK“ the desired scaling method. (Automatically or manually)

In case of **AutoRange = off** with „Scale 4mA“ und „Scale 20mA“ the scale ranges needs to be defined.

Select with button „ $\Delta$ “ the item „Scale 4mA“ or „Scale 20mA“ and confirm with „OK“ .

Input of the scaling values will be analogous as described before for value settings.

Using „CLR“ clears up the complete settings at once.

For „Auto on“ , the max. scaling is calculated based on the inner tube diameter, max. measurement range and the reference conditions settings.

Take over of the inputs with „Save“ and leaving the menu with „Back“.

Settings → 4-20mA → Error Current

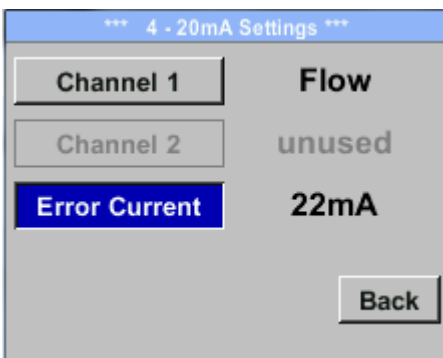

This determines what is output in case of an error at the analog output.

- 2 mA Sensor error / System error
- 22 mA Sensor error / System error
- None Output according Namur (3.8mA – 20.5 mA)  
 < 4mA to 3.8 mA Measuring range under range  
 >20mA to 20.5 mA Measuring range exceeding

To make changes first select a menu item "Current Error" with button „ $\Delta$ “ and then select by pressing the „OK“ the desired mode

For saving the changes done press button „Save“ to discard the changes press button „Cancel“.

Leaving the menu with „Back“.

### 10.3.8 VA 525 Info

#### Settings → Info

*** Info ***	
<b>Production Datas</b>	
Serial No.:1234567890	<a href="#">Details</a>
Cal. Date: 10.01.2013	
<b>Sensor Datas</b>	
Sensor Type: IST 1.8	
Max Speed: 92,7 m/s	600m³/h
Max Temp: 100.0 °C	
<b>Live Datas</b>	
Run Time: 2d 21h 23m 12s	
Vin: 23,8V	Temp: 35,8
<a href="#">Options</a>	<a href="#">Back</a>

*** Calibration Details ***	
<b>Calibration Conditions</b>	
Ref. Pressure:	1000.00mbar
Ref. Temperature:	20 °C
Cal. Diameter:	53,1 mm
Cal. Pressure:	6000.00mbar
Cal. Temperature:	23 °C
Cal. Points:	10
<a href="#">Back</a>	

Here you get a brief description of the sensor data incl. the calibration data.

Under *Details*, you are able to see in addition the calibration conditions.

## 10.4 MBus

### Settings → MBus

The Sensor offers two possibilities for coding the Value Information Field (VIF).

- Primary VIF (The units and multiplier correspond to MBus Org. specification 4.8 chapter 8.4.3)
- Plain text VIF ((units are transmitted as ASCII characters. So units that are not included in MBus specification chapter 8.4.3 are possible)

Switch to Plain Text VIF by activation of „Units as String“.

### 10.4.1 Default Settings communication

Primary Address*:	1
ID:	Serial number of Sensor
Baud rate*:	2400
Medium*:	depending on medium (Gas or Compressed Air)
Manufacturer ID:	CSI
VIF coding:	Primary VIF

Both addresses, Primary address and ID, could be automatic searched in the M-Bus system.

### 10.4.2 Default values transmitted

Value 1 with [Unit]*:	Consumption [m <sup>3</sup> ]
Value 2 with [Unit]*:	Flow [m <sup>3</sup> /h]Consumption [m <sup>3</sup> ]
Value 3 with [Unit]*:	Gas temperature [°C]

\*All Values could be changed / preset in production or with CS Service software (Order-No. 0554 2007)

## 11 Status / Error messages

### 11.1 Status messages

- **CAL**

On the part of CS Instruments GmbH & Co.KG a regular re-calibration is recommended, see chapter 13. At delivery, the date at which the next recalibration is recommended is internally entered. When this date is reached, a message appears in the display with the status message „CAL“.

**Note:** The measurement will continue without interruption or restriction.

- **Direction**

When used in conjunction with a direction switch VA409, the status message "Direction" is displayed in case of opposite flow direction and no measurement may take place.

**Status messages:**

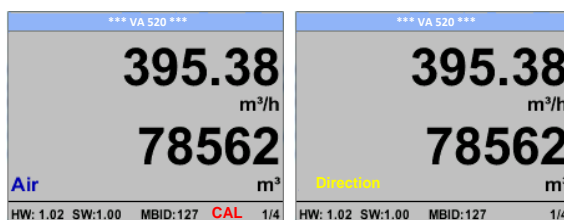

## 11.2 Error messages

- **Low Voltage**

If the supply voltage is less than 11V, the warning message „**Low Voltage**“ is displayed. This means that the sensor can no longer work / measure correctly and thus there are none measured values for flow, consumption and speed are available.

- **Heater Error**

The error message „**Heater Error**“ occurs in case of failure of the heating sensor.

- **Internal Error**

In the case of this message „**Internal Error**“, the sensor has an internal read error on e.g. EEPROM, AD converter etc. detected.

- **Temp out of Range**

At media temperatures outside the specified temperature range, the status message „**Temp out of Range**“ occurs.

This temperature overshoot leads to incorrect measurement values (outside the sensor specification).

- **Low Voltage 4-20mA**

For sensors with a galvanically isolated 4-20mA output, a min. Supply voltage of 17.5V is required. If this value is undershot, the error message „**Low Voltage 4-20mA**“ is displayed.

### Error messages:

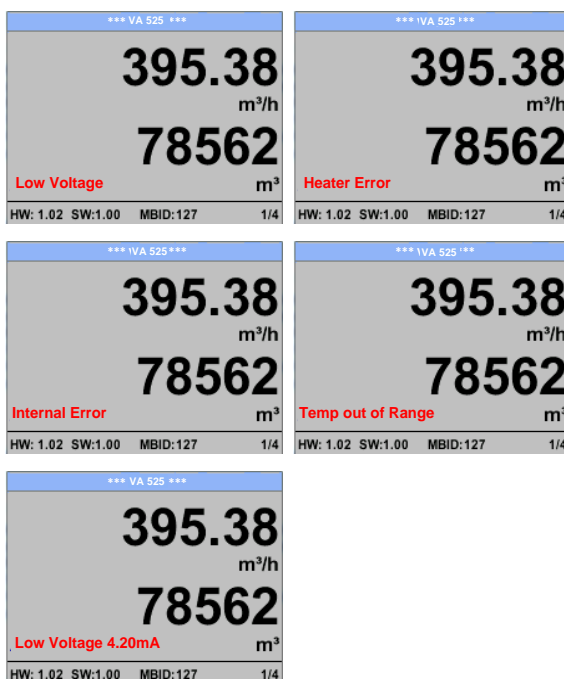

## 12 Maintenance

The sensor head should be checked regularly for dirt and cleaned if necessary. Should dirt, dust or oil accumulate on the sensor element, a deviation will occur in the measuring value. An annual check is recommended. Should the compressed air be heavily soiled this interval must be shortened.

## 13 Cleaning of the sensor head

The sensor head can be cleaned by carefully moving it in warm water with a small amount of washing-up liquid. Avoid physical intervention on the sensor (e.g. using a sponge or brush). If soiling cannot be removed, service and maintenance must be carried out by the manufacturer.

## 14 Re-Calibration

If no customer specifications are given then we recommend to carry out calibration every 12 months. For this purpose the sensor must be sent to the manufacturer.

## 15 Spare parts and repair

For reasons of measuring accuracy spare parts are not available. If parts are faulty, they must be sent to the supplier for repair.

If the measuring device is used in important company installations, we recommend keeping a spare measuring system ready.

## 16 Calibration

According to DIN ISO certification of the measuring instruments we recommend to calibrate and if applicable to adjust the instruments regularly from the manufacturer. The calibration intervals should comply with your internal specification. According to DIN ISO we recommend a calibration interval of one year for the instrument VA 525.

On request and additional payment, calibration-certificates could be issued. The precision is given due to use DKD-certified flow meters and verifiable

## 17 Warranty

If you have reason for complaint we will of course repair any faults free of charge if it can be proven that they are manufacturing faults. The fault should be reported immediately after it has been found and within the warranty time guaranteed by us. Excluded from this warranty is damage caused by improper use and non-adherence to the instruction manual.

The warranty is also cancelled once the instrument has been opened - as far as this has not been mentioned in the instruction manual for maintenance purposes - or if the serial number in the instrument has been changed, damaged or removed.

The warranty time for the VA 525 is 12 months. If no other definitions are given the accessory parts have a warranty time of 6 months. Warranty services do not extend the warranty time.

If in addition to the warranty service necessary repairs, adjustments or similar are carried out the warranty services are free of charge but there is a charge for other services such as transport and packaging costs. Other claims, especially those for damage occurring outside the instrument, are not included unless responsibility is legally binding.

### After sales service after the warranty time has elapsed

We are of course there for you even after the warranty time has elapsed. In case of malfunctions, please send us the instrument with a short-form description of the fault. Please do not forget to indicate your telephone number so that we can call you in case of any questions.

# KONFORMITÄTSERKLÄRUNG

## DECLARATION OF CONFORMITY

Wir CS Instruments GmbH & Co.KG  
 We Am Oxeer 28c, 24955 Harrislee

Erklären in alleiniger Verantwortung, dass das Produkt  
 Declare under our sole responsibility that the product

**Verbrauchs-/ Durchflusssensor VA 525**  
 Flow Sensor VA 525

den Anforderungen folgender Richtlinien entsprechen:  
 We hereby declare that above mentioned components comply with requirements of the following EU directives:

<b>Elektromagnetische Verträglichkeit</b> Electromagnetic compatibility	<b>2014/30/EU</b> 2014/30/EC
<b>RoHS</b> (Restriction of certain Hazardous Substances)	<b>2011/65/EC</b>

### Angewandte harmonisierte Normen:

Harmonised standards applied:

<b>EMV-Anforderungen</b> EMC requirements	<b>EN 55011: 2016</b> <b>EN 61326-1: 2013-07</b>
--	---

Anbringungsjahr der CE Kennzeichnung: 18

Year of first marking with CE Label: 18

Das Produkt ist mit dem abgebildeten Zeichen gekennzeichnet.  
 The product is labelled with the indicated mark.

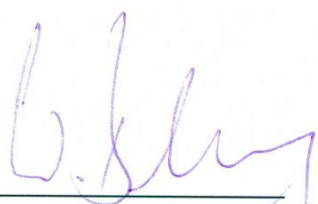

Harrislee, den 23.11.2018

  
 Wolfgang Blessing Geschäftsführer